

# INSTRUCTION MANUAL

## CA-SVW-UAR.002AE

### INFODAPTER

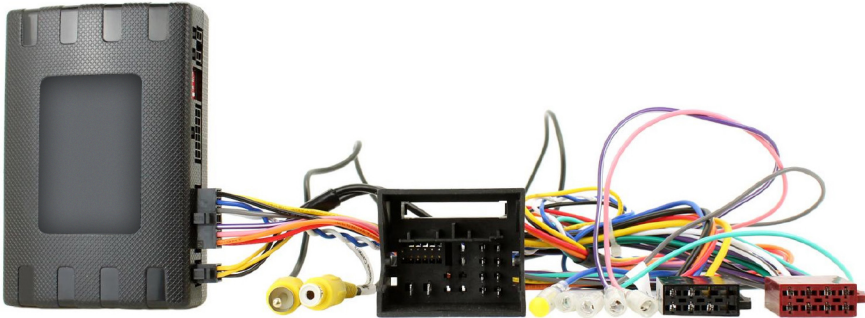

---

## APPLICATION

Volkswagen Beetle 2015>  
Volkswagen Caddy 2015>  
Volkswagen Jetta 2015>  
Volkswagen Sharan 2015>  
Volkswagen T-6 2015>  
Volkswagen Tiguan 2015>

*For AV Aftermarket Head Units Only*

---

## KEY FEATURES

- Retains Steering Wheel Controls
- Retains Optical Parking Sensor Display
- Retains Climate Control Visualisation

# DIP SWITCH SETTINGS

See Fig 1.

Up = Off, Down = On

1: On = Pioneer head units.

2: Setting for reverse camera. On = PAL, Off = NTSC. The default setting is Off (NTSC).

3: Resets the display settings back to default. If the display settings have been manipulated in a way that it is no longer possible to make adjustments, change the DIP switch #3 from Off to On and back. This will reset the screen settings to the factory defaults. During this procedure the screen background will change to red. While the background is red, no settings can be made.

4: Not applicable

## Interface Connections

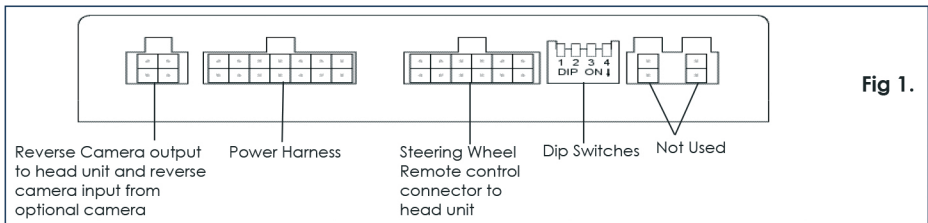

Fig 1.

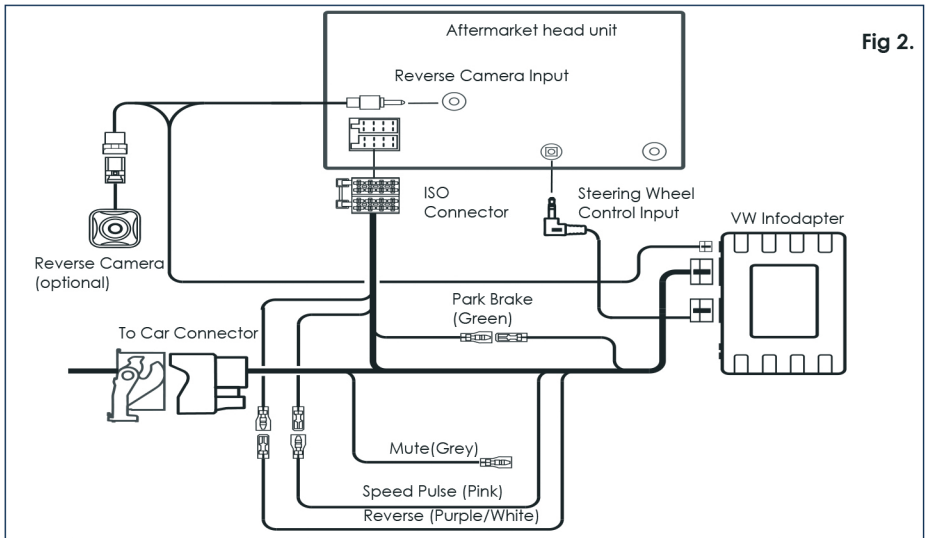

Fig 2.

# Steering Wheel Controls

À Speech Button

B/C Track Up/Down

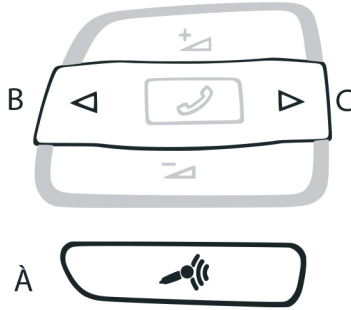
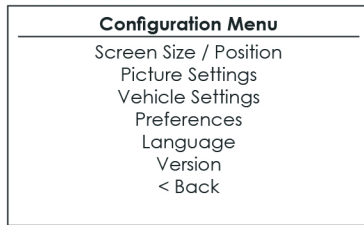

Fig 3.

# Configuration Menu

To access the menu, **push and hold the speech button** for 2 seconds (Fig. 3). This will enable the configuration menu. To navigate through the menu options use the **Track Up/Track Down buttons**. To select a menu option, push the **speech button once**.



- Screen Size/Position**  
 Make sure all 4 corner markers are touching the corners of the aftermarket head unit display.

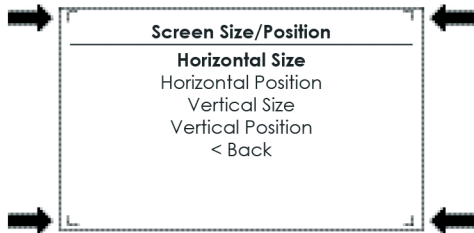

- Picture Settings**  
 Adjust brightness, contrast, and colour saturation.

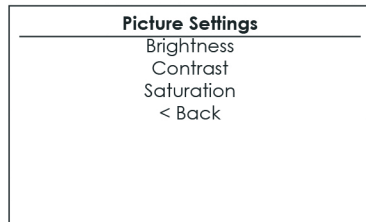

# Configuration Menu...continued

- **Vehicle Settings**

- Driver Position - Select Left or Right depending upon vehicle configuration.

Vehicle Settings	
Driver Position	Left
Amplifier Settings	
<Back	

- Amplifier Settings\* - This setting can be used to adjust the gain of the aftermarket head unit, to match the the OEM amplifier volume. (\*Note this option is only available when an OEM amplifier is detected in the vehicle)

Amplifier Settings	
Volume	2
Balance	0
Fader	0
Bass	0
Mid	0
Treble	0
On Delay	0
< Back	

- **Preferences**

**Park Assist Version** - Select according to the colour configuration of the park assist fitted to the vehicle.

**Camera Connected** - Select Yes if an optional camera is connected.

Preferences	
Park Assist Version	0
Camera Connected	Yes
Reverse Priority	Park Assist
Park Brake Source	Always On
Restore factory settings	
< Back	

**Reverse Priority\*** - Select which image (Camera or Park Assist) will be shown by default when reversing. The driver can select the desired image by pushing the Speech button (Fig.3) while reversing. (\*Note this option is only available when Camera Connected is set to Yes)

**Park Brake Source** - Set to one of the following:  
 Brake - Park brake output active when park brake is on.  
 Speed - Park brake output active when speed is less than 3KMH  
 Always On - Park brake output always active.

**Restore factory settings** - Reverts all Infodapter settings to factory defaults. (This does not restore vehicle settings)

**Legal Information**

Please consult the relevant road traffic laws governing the country in which this product is being operated. No liability is accepted for material damage, loss or personal injury, directly or indirectly, from installation and operation of this product. This product should only be operated when safe to do so.